

HARDY

PROCESS SOLUTIONS

Measurement ■ Automation ■ Productivity

A Roper Technologies Company

Hardy Caseweigher



Encompass™
Product Partner

A ROCKWELL AUTOMATION PARTNER
Global



Easiest to Use | Highest Performance | Lowest Total Cost

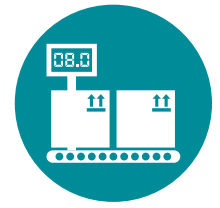

**SHIP
Product
Inspection**

Redefining How Check-Weighing Machinery is Built, Integrated, Used and Maintained



Open Source

Hardy Caseweighers are built on a PLC platform – making it easy to modify the machine program to accommodate current manufacturing & data requirements, yet flexible enough to meet future needs. Customize the HMI to show information important to your process. Available with an Allen Bradley® 1769 PLC and HMI.



Off-the-Shelf

Simple design and minimal use of custom parts. Controls built using readily available components such as the PLC, HMI and Power Supply – making replacement, emergency repairs or upgrades quick and easy. Plenty of spare I/O and the ability to expand provide a future proof control platform.



Seamless Integration

Machine communications over an EtherNet/IP backbone make integration quick and data exchange simple. Serve up process statistics, manufacturing performance and machine status to you control network by addressing the equipment thru one of the spare Ethernet ports available or add a network switch to tie in additional peripherals such as printers, bar code reads or vision systems. Use readily available real-time data to optimize upstream processes or create closed-loop control by exchanging tags with another device on the network.

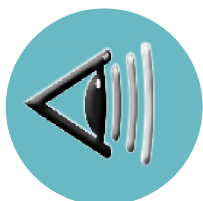

CheckMaster Software

Built in VISUALIZATION TOOLS eliminate the trial & error process of product set-up, enabling operators to capture the entire checkweighing process and display it on the machine's high-resolution screen. Quickly and easily determine the perfect set of parameters to maximize weight capture time and optimize for repeatability and accuracy. Real-time accuracy (3-Sigma) tracking, automatic off-set calculation, statistics package and Hardy weightless C2 calibration are all standard features with every machine.

Key Features

User Experience

- Simple Product Selection
- 50 Recipe Memory (Upgradable)
- Fast Product Set-Up
 - Weightless Calibration
 - Automatic Dynamic Off-Set Calculation
 - Automatic Filter Setting
 - Automatic Standard Deviation / 3 Sigma Calculations
 - Push Button Recipe Transfer
- Product Statics Included
 - Give Away
 - Rejects
 - 3-Sigma
 - Product Rate
- Simple data transfer via USB (.csv)
- Visual-based Machine Set-UP ('See it' machine tuning)

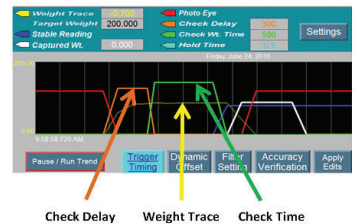

Display

- PanelView Plus 7 HMI
- Commercial off-the-shelf (COTS)
- Programmable (Customizable UI/UX)
- Class I Division 2



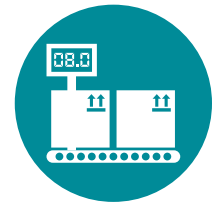
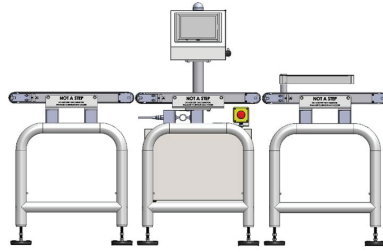

**SHIP
Product
Inspection**

Controls

- **Hardy's HI4050 Check Weight Controller** featuring:
 - Waversaver+ (Lighting fast filtering = ACCURATE STABLE WEIGHT)
 - C2 – Second Generation Calibration (Weightless Calibration)
 - PE FREE operation (Reliable weight capture without photo eyes)
 - 100-year-old Scale Company (Dependable Experience)
- **Allen-Bradley® CompactLogix® 1769 PLC** featuring:
 - Programmable and Expandable
 - EtherNet/IP® connectivity
 - Embedded SD memory port
 - Expandable digital Point I/O
 - Expandable analog Point I/O
 - Build-in Data Logging
- **Allen-Bradley® Stratix Switch** with 2 spare ports
- **PanelView® Plus 7 HMI**



Mechanics

- **Commercial Off-The-Shelf Parts (COTS)**
- **Durable Steel Frame**
 - Ridged 2" Diameter Tubing
 - Robust Continuous Welds
 - Easy to clean
 - Powder coated carbon steel or upgrade to all stainless
- **Simplified Design** (All-in-one Motor Drive Rollers)
 - No belts
 - No gears
 - No pulleys
 - Safe: no pinch-points
- **Large Electrical Enclosure Frame**
 - Future-proof - room to add components/features
 - Well organized, simple to troubleshoot

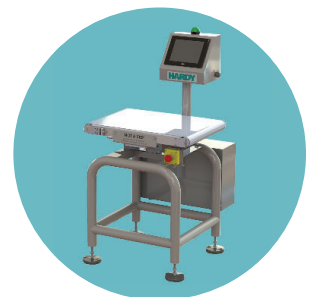
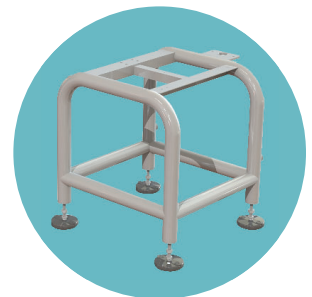

Technical Information

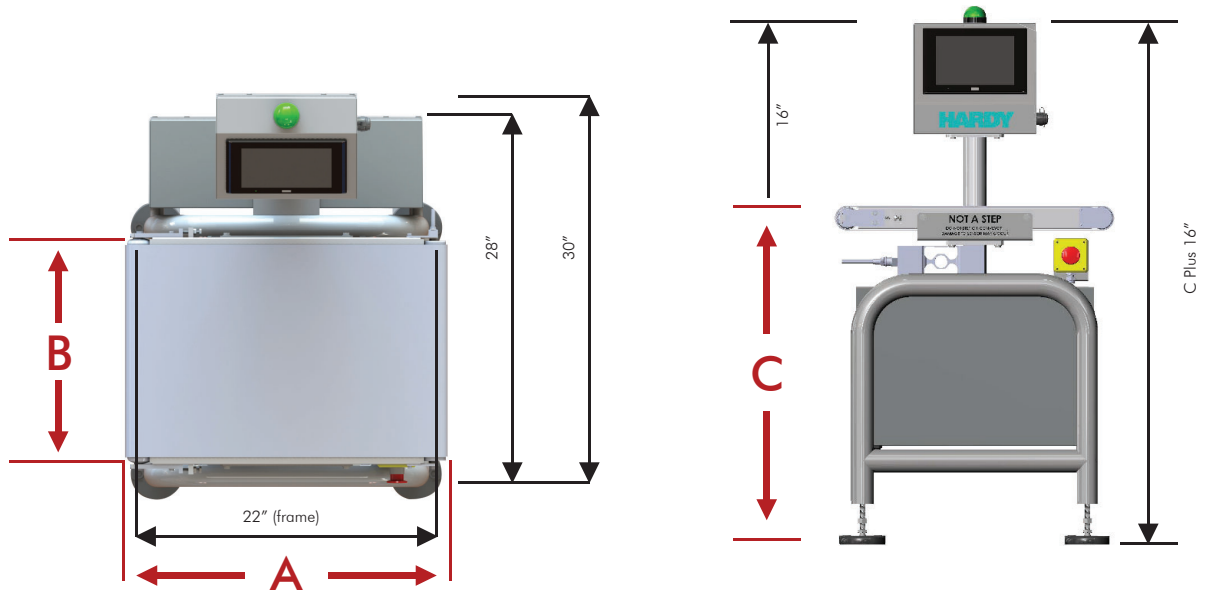

	Size 1	Size 2	Size 3
A Conveyor Length	24"	28"	32"
B Conveyor Width	16"	18"	24"
C Conveyor Height	User Defined*	User Defined	User Defined

* Standard Height range from 24" to 44" based on nominal adjustable leg position of +/-2".

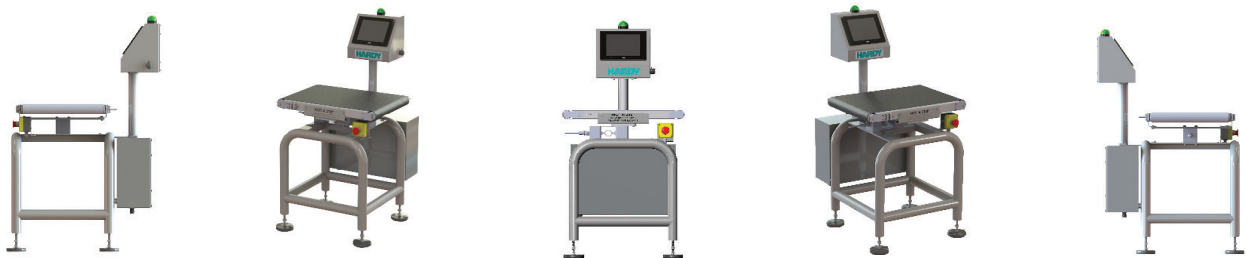

How to Order

1. Using Throughput Tables, determine the minimum bed length required to achieve desired throughput (PPM). If package size is not listed, round up to the next nearest size. NOTE: the in-feed conveyor speed must match conveyor speed found in tables to ensure proper operation.
2. Verify package width does not exceed bed size selected.
3. Select frame material - Galvanized or Stainless Steel
4. Select Control Scheme - Allen-Bradley
5. Select Drive configuration. Choose 1 drive for packages up to 40 lbs, 2 drives for packages over 40 lbs. Choose Galvanized for IP54 environments or Stainless for IP65 environments.
6. Finish by selecting direction of conveyor, belt material and any additional options.

Performance

Minimum Conveyor Speed – 20 FPM

Maximum Conveyor Speed – 150 FPM

Rated Capacity – 55 lbs (24.95 Kg)

Accuracy* – 0.05 lbs (22.68 grams)

Safe Overload* – 350 lbs (158.76 Kg)

*Accuracy is contingent on package type, conveyor speed, product transfer and environmental conditions.

General

Connections	USB; Ethernet TCP/IP; Ethernet/IP
Power Consumption	120VAC Single Phase / 3 A / 50-60 Hz
Air Requirements	60 - 80 psi (only required when reject option ordered)
Operating Temperature	14 to 105°F (-10 to +40°C)
Relative Humidity	20 - 90%, non-condensing
Frame Options	Gray powder coated carbon steel Optional 304 stainless steel
Roller Options	1.9" galvanized rated to IP54 Optional 1.9" 304 stainless rated to IP66
Control System Options	Standard Controls Optional Standard Controls with EtherNet/IP® Optional Premium Allen-Bradley® PLC and HMI
Reject Options	Swing Gate Diverter
Belt Options	2-ply check-out style belting Optional FDA approved belting

Throughput Tables

Package Length

		24" Long Conveyor	22"	20"	18"	16"	14"	≤ 12"
Throughput (PPM) Parts Per Minute	10 PPM	20 FPM	20 FPM	20 FPM	20 FPM	20 FPM	20 FPM	20 FPM
	20 PPM	40 FPM	40 FPM	40 FPM	40 FPM	40 FPM	40 FPM	40 FPM
	30 PPM	-	60 FPM	60 FPM	60 FPM	60 FPM	60 FPM	60 FPM
	40 PPM	-	-	80 FPM	80 FPM	80 FPM	80 FPM	80 FPM
	50 PPM	-	-	100 FPM	100 FPM	100 FPM	100 FPM	100 FPM
	60 PPM	-	-	-	120 FPM	120 FPM	120 FPM	120 FPM
	70 PPM	-	-	-	-	140 FPM	140 FPM	140 FPM
		28" Long Conveyor	26"	24"	22"	20"	18"	≤ 16"
Throughput (PPM) Parts Per Minute	8 PPM	20 FPM	20 FPM	20 FPM	20 FPM	20 FPM	20 FPM	20 FPM
	17 PPM	40 FPM	40 FPM	40 FPM	40 FPM	40 FPM	40 FPM	40 FPM
	25 PPM	-	60 FPM	60 FPM	60 FPM	60 FPM	60 FPM	60 FPM
	34 PPM	-	-	80 FPM	80 FPM	80 FPM	80 FPM	80 FPM
	42 PPM	-	-	100 FPM	100 FPM	100 FPM	100 FPM	100 FPM
	51 PPM	-	-	-	120 FPM	120 FPM	120 FPM	120 FPM
	60 PPM	-	-	-	-	140 FPM	140 FPM	140 FPM
		32" Long Conveyor	30"	28"	26"	24"	22"	≤ 20"
Throughput (PPM) Parts Per Minute	7 PPM	20 FPM	20 FPM	20 FPM	20 FPM	20 FPM	20 FPM	20 FPM
	15 PPM	40 FPM	40 FPM	40 FPM	40 FPM	40 FPM	40 FPM	40 FPM
	22 PPM	-	60 FPM	60 FPM	60 FPM	60 FPM	60 FPM	60 FPM
	30 PPM	-	-	80 FPM	80 FPM	80 FPM	80 FPM	80 FPM
	37 PPM	-	-	100 FPM	100 FPM	100 FPM	100 FPM	100 FPM
	45 PPM	-	-	-	120 FPM	120 FPM	120 FPM	120 FPM
	52 PPM	-	-	-	-	140 FPM	140 FPM	140 FPM

Conveyor Speed Stated in FPM – Feet Per Minute

It is the responsibility of the customer to deliver the products spaced and at infeed speeds as stated in the above tables to achieve optimal equipment and stated accuracies. Please contact your local representative to discuss additional material handling solutions available to ensure infeed speeds match required checkweigher conveyor speeds to achieve desired throughput. Only one product can be on the checkweigher at a time. For example, when running a 12" product across a 24" long conveyor – the pitch must be greater than 24", the gap must be greater than 6".

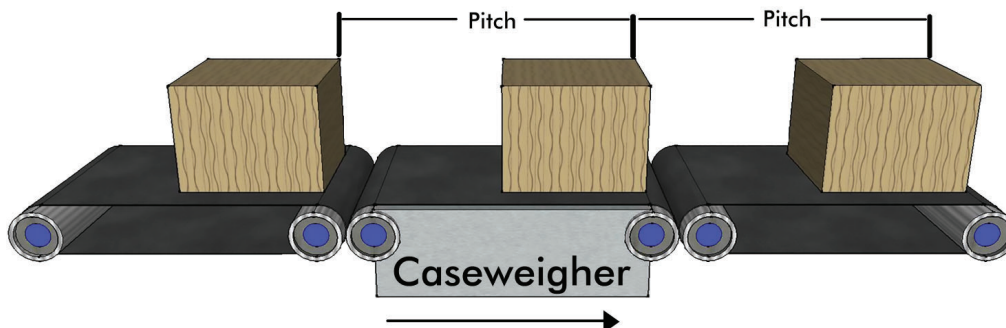

Proven Solutions

For more than 100 years Hardy Process Solutions, headquartered in San Diego, California, has been providing innovative process control solutions. With that, we have saved our customers thousands of production hours and millions of dollars. Our goal is to provide superior weighing equipment as an industrial scale company that stays on the pulse of innovations in the field. At Hardy, we pride ourselves on the ability to continuously provide superior product quality and excellent customer support, which enables our customers to achieve their process goals.



Hardy delivers high performance weighing solutions with the **LOWEST TOTAL COST** to own. We include Industry Leading Technology in all of our scales and instruments to make it **EASY** for you to install, integrate, and maintain. Powerful solutions that are easy to use is why our customers realize increased production efficiency.

Instant Information

We offer instant access to videos, white papers, articles, case studies brochures, application notes, and more.



Simply go to:
www.hardysolutions.com/media-center/view



Headquarters:
 10075 Mesa Rim Road
 San Diego, CA 92121
 tel. +1-858-278-2900
 tel. 800-821-5831
 fax +1-858-278-6700
www.hardysolutions.com
hardyinfo@hardysolutions.com



FREE Online and Phone Support
1-800-821-5831
www.hardysolutions.com

Unrestricted Access to Manuals and Drawings Online
 Free Dial-In Technical Support and Applications Support
 Onsite Certified Technicians for Hire



Follow us on Facebook and LinkedIn

